

## High-Accuracy Height Gauge Linear Height LH-600F/FG



# Easy operation and **High-accuracy**

## High-Accuracy Height Gauge **LH-600F/FG**

- Suitable for even beginners, navigate easily via keypad and touchscreen operation
- Conduct various measurements such as 2D measurement and perpendicularity measurement with just one tool
- Optional probes provide versatile measurement capabilities
- Enhanced data output functions make it easier to manage your measurement data



Linear Height

## Suitable for even beginners, navigate easily via keypad and touchscreen operation

Measurements are supported via clear guidance on the large touch panel



### Simple, straightforward keys with icons

Icons allow the user to find the required operation at a glance.

#### Basic measurements

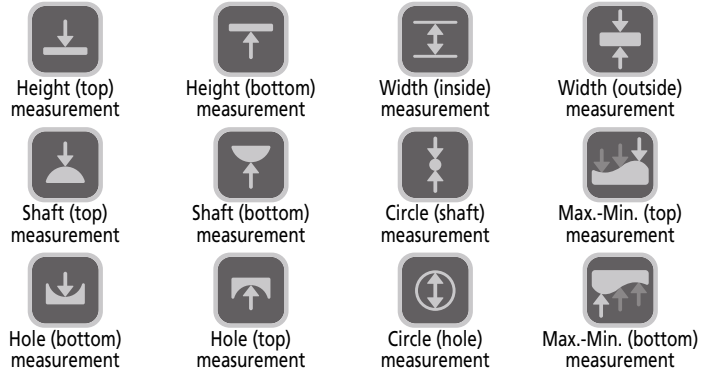

#### Advanced measurement functions

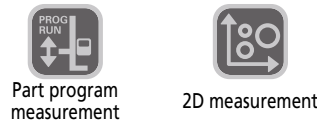

#### Power



### Touch panel with guidance

Measurement guidance is displayed on the large touch panel of the 8,4-inch color LCD, enabling intuitive operation.



Guidance screen



Operable with gloves

#### Measurement settings



#### Other



## Fantastic features for shop floor use

### Automatic scale check



On start up the user is led through the menu to set the scale origin and run the automated procedure to check the scale for contamination.

### Calibration reminder

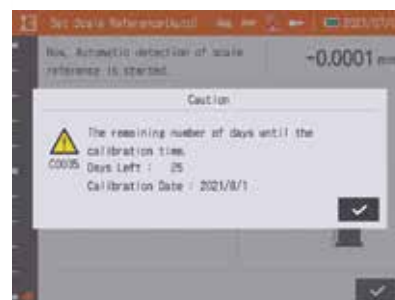

A notification will be displayed before the calibration due date that the user has set.

### Home screen

With the intuitive menu, even beginners can easily access various operations and settings.

The home screen displays a 'TOP MENU' with a home icon, unit settings (deg, mm, ABS), and a date (2021/07/07). A message states 'Measurement can be started. (Touch icon, or Push the Sheetkey)'. A large numerical display shows '0.0000 mm'. Below this is a grid of measurement icons. At the bottom, there are icons for 'Measurement results' and 'General settings'.

Touch panel  
or  
Sheet key

Measurements

- Basic measurements (ABS)
- Basic measurements (ABS, INCx5)
- Angle measurements
- Hole position measurements
- Perpendicularity and straightness measurements
- 2D measurements
- Part program measurements (1D, 2D)

Measurement results      General settings

### Guidance and measurement navigation

Available in 21 languages, each measurement step is displayed in a way that is easy to understand for the user.

The sequence shows the following steps:

- Select basic measurements:** The user selects an icon from the measurement grid.
- Select a measurement method:** The user selects a specific method from a sub-menu.
- Conduct the measurement:** The user performs the measurement, with the screen showing a value of 66.9020 mm.
- View the measurement results:** The final results are displayed, including Z: 81.8540 mm, D: 30.3380 mm, and ΔZ: 0.0000 mm.

Select basic measurements      Select a measurement method      Conduct the measurement      View the measurement results

### Operation log



Operation log data is retained for up to 2 months, and can be output to a USB memory device.

### Repeat measurement function

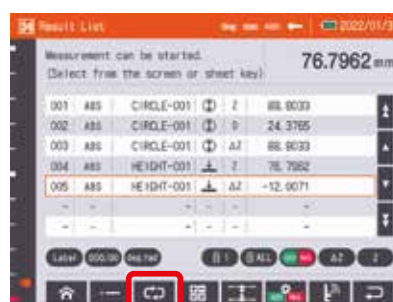

To enable efficient measurements the user can repeat the last measurement with the optional footswitch or on-screen button.

# Various measurements with just one unit

Improved usability and accessibility, including advanced measurement functions

## 2D measurement "Pre-placement"

This function allows the user to register the hole position of the workpiece before measurement.

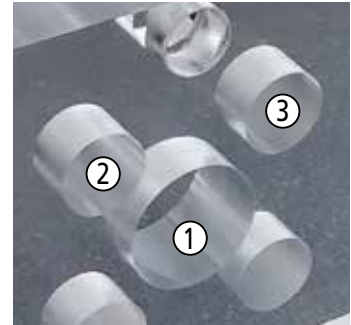
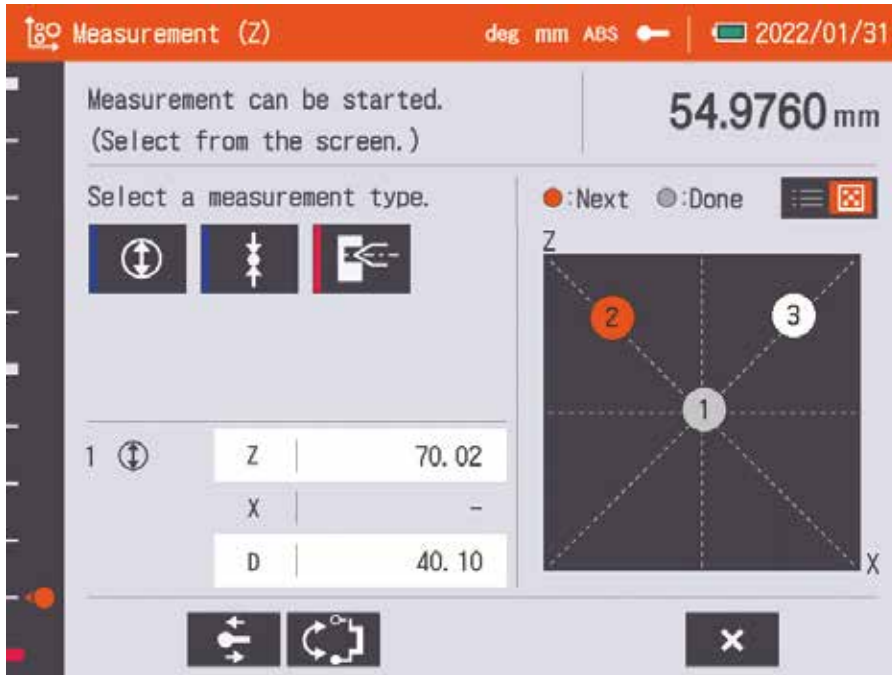

## Perpendicular/straightness measurement "Graph Creation"

You can check the measurement results of perpendicularity and straightness in real-time during measurement. After the measurement, you can easily see the trends of the measurement results in a graph.

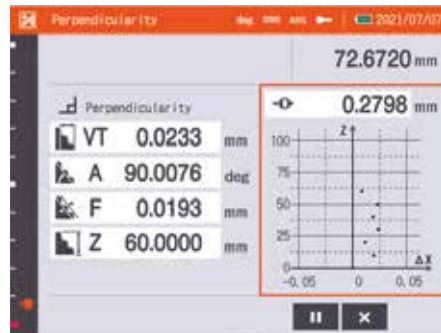

Real-time results during measurement



Results post measurement



Previous measurement results



Graph display of measurement results

## Part program measurement

You can easily access and use the functions of Create, Run, Edit, and View results of part programs.

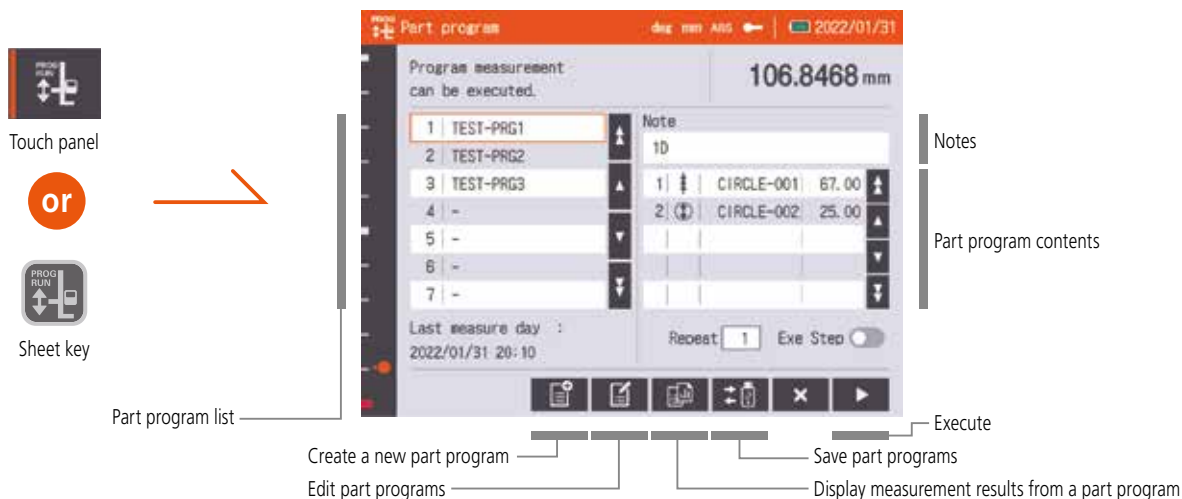

### Example of performing part program measurement

Run the program repeatedly (when the number of executions is >1)



### Copy part programs to other devices

You can copy part programs to other devices via USB storage device.

## Expanded measurement area

With the new optional probes, you can now measure areas that were beyond the capacity of conventional probes.

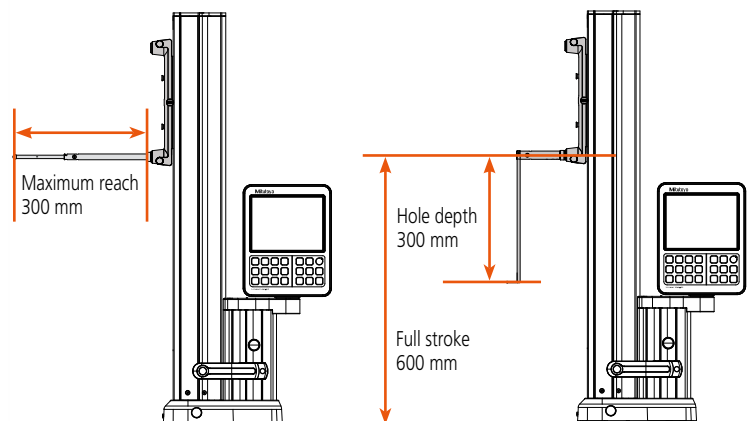

### Example of deep hole measurement

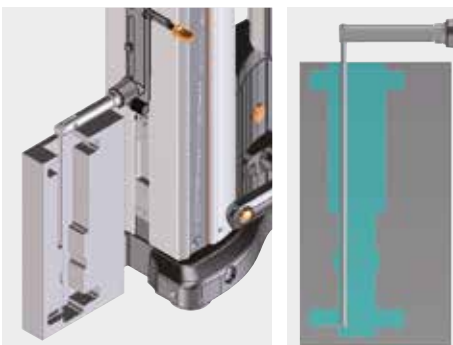

# Optional probes provide versatile measurement capabilities

An extension holder and a depth stylus extend the measuring range both horizontally and vertically

Three types of optional probes:

1. The holder and the stylus can be freely combined according to the purpose of measurement, and the measurement area can be changed.
2. This type is used for single-use measurements such as measuring a tapered hole or a knife edge.
3. This type is used to measure straightness and perpendicularity.

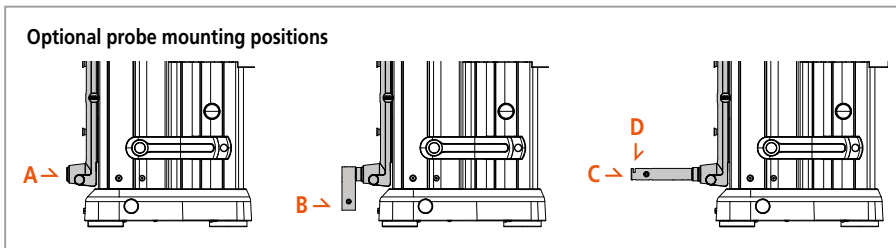
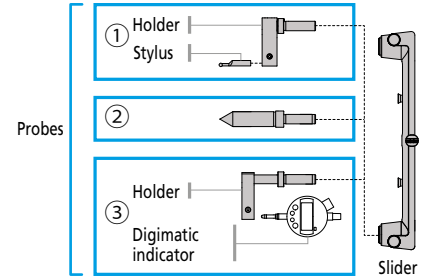











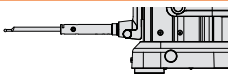

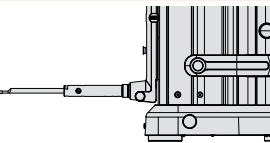







You can adjust the balance of the slider by adjusting the number of auxiliary weights. (Magnetic auxiliary weights are easy to add and remove.)

## Holders/styli for position A

	Part No.	Product name	Number of weights
<b>Mounting example</b> For extension holder 100 		<b>12AAY343</b> ø5 stepped probe (standard accessory)	2
		<b>12AAA792</b> Holder for dial indicator (millimeter)	0
For depth measurement probes		<b>12AAA793</b> Holder (long)	*1
		<b>12AAB136</b> ø10 cylindrical universal probe	2
For taper stylus (ø20)		<b>12AAY595</b> Extension holder 100	*1
		<b>12AAY596</b> Extension holder 200	*1
		<b>12AAC072</b> Depth probe	2
		<b>12AAC073</b> Tapered stylus (ø20)	2







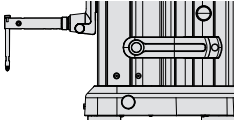

\*1: Please refer to page 9 for the number of weights to be used.

## Styli for position B/C

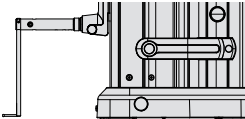
	Part No.	Product name	Number of weights <sup>*3</sup>
<b>Mounting example</b> Φ5 ball stylus L130 in position B 	 <b>12AAF666</b>	ø1 ball stylus (coaxial type)	2
	 <b>957261</b>	ø2 ball stylus (coaxial type)	2
<b>Mounting example</b> Φ5 ball stylus L130 in position C 	 <b>12AAF667</b>	ø2 ball stylus (coaxial type), ruby ball	2
	 <b>957262</b>	ø3 ball stylus (coaxial type)	2
	 <b>957263</b>	ø4 ball stylus (coaxial type)	2
	 <b>12AAB552</b>	ø10 ball stylus (coaxial type), L=50	2
	 <b>12AAF668</b>	ø10 ball stylus (coaxial type), L=82	1
	 <b>12AAF669</b>	ø10 ball stylus (coaxial type), L=120	1
	 <b>12AAF670</b>	ø5 disk stylus	2
	 <b>12AAF671</b>	ø10 disk stylus	2
	 <b>957264</b>	ø14 disk stylus	2
	 <b>957265</b>	ø20 disk stylus	2
	 <b>12AAF672</b>	ø1 ball stylus (eccentric type)	2
	 <b>12AAF673</b>	ø2 ball stylus (eccentric type)	2
 <b>12AAA788</b>	ø4 ball stylus (eccentric type)	2	
 <b>12AAA789</b>	ø6 ball stylus (eccentric type)	1	
 <b>226117</b>	Shank with M2 thread <sup>*2</sup>	2	
 <b>226118</b>	Shank with M3 thread <sup>*2</sup>	2	
 <b>12AAY597</b>	ø5 ball stylus L130	1	
 <b>12AAY598</b>	ø25 disk stylus	1	

\*2: Stylus for coordinate measuring machine can be mounted. \*3: When using an extension holder. Note: Where the material is not described, the tip of the stylus is carbide.

## Styli for position D

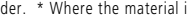
	Part No.	Product name	Number of weights <sup>*4</sup>
<b>Mounting example</b> Depth stylus 70 is mounted in position D 	 <b>12AAY599</b>	Depth stylus 70	2
	 <b>12AAY600</b>	Depth stylus 150	1
<b>Mounting example</b> Depth stylus 150 ø4 ball is mounted in position D 	 <b>12AAY601</b>	Depth stylus 300	0
	 <b>12AAY602</b>	Depth stylus 70 ø2 ball	2
	 <b>12AAY603</b>	Depth stylus 150 ø2 ball	1
	 <b>12AAY604</b>	Depth stylus 300 ø2 ball	0
	 <b>12AAY605</b>	Depth stylus 70 ø4 ball	2
	 <b>12AAY606</b>	Depth stylus 150 ø4 ball	1
	 <b>12AAY607</b>	Depth stylus 300 ø4 ball	0

\*4: Can only be attached to the extension holder. \* Where the material is not described, the tip of the stylus is carbide.

## Enhanced data output functions make it easier to manage your measurement data

Data output improves work efficiency and the reliability of recorded data

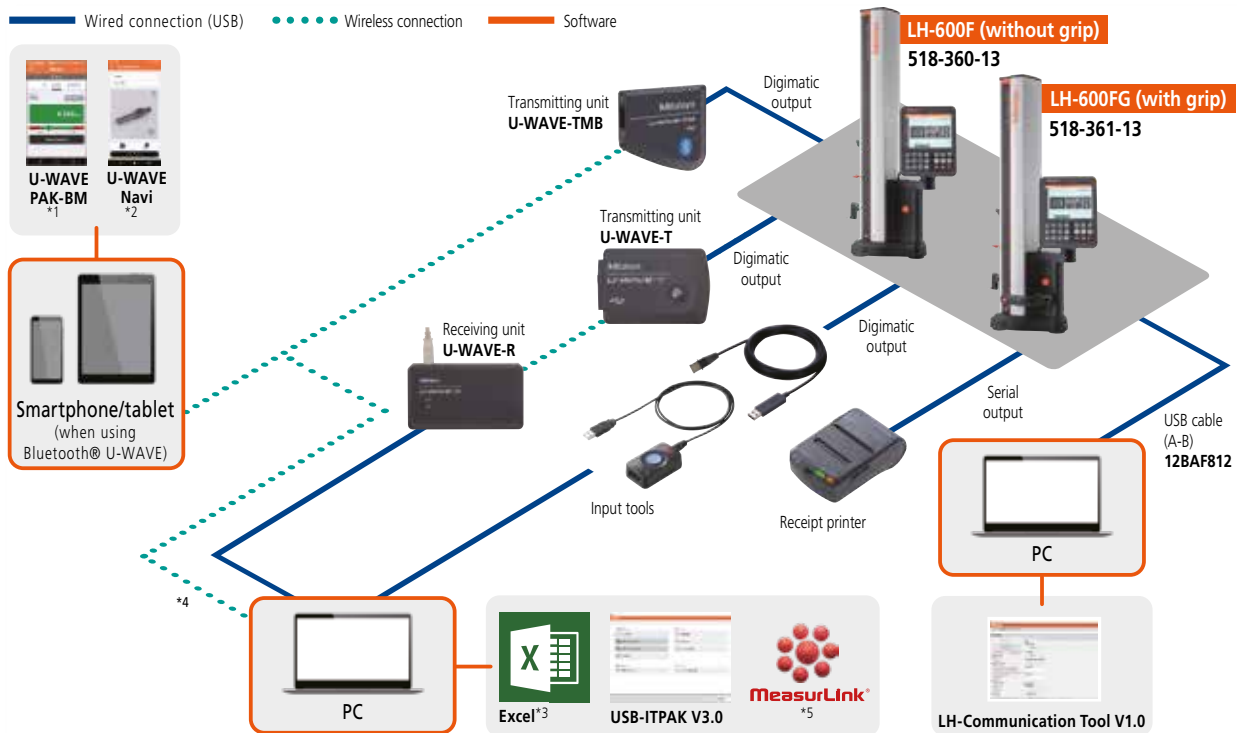

\*1: Available at Apple Store and Google Play for free download. \*2: Available at Google Play for free download.  
 \*3: Excel is a registered trademark of Microsoft Corporation. \*4: It is also possible to connect with a Bluetooth-compatible PC.  
 \*5: MeasurLink® is a registered trademark of Mitutoyo Corporation (Japan) and Mitutoyo America Corporation (USA).

### Optional products for outputting measurement data

Part No.	Product name
12AA483	Receipt printer (for EU countries, excluding the UK) <sup>*6</sup>
12AA484	Receipt paper (for the UK) <sup>*6</sup>
12AAN052	Printer paper for receipt printer (set of 10)
12AA485	Printer mounting attachment
12AAN146	Connection cable for printer
—	(USB memory device) <sup>*7</sup>
12BAF812	USB cable (type A - type B) (2 m)
543-700B	Digimatic indicator (ID-C0512NXB)
543-701B	Digimatic indicator (ID-C0512MNXB)
519-521	Lever head probe MLH-521
519-561	Mu-checker M-561
936937	Digimatic cable (1 m)
965014	Digimatic cable (2 m)

Part No.	Product name
264-505D	Digimatic mini processor (DP-1VA) (with AC-Adapter CEE Type)
264-505E	Digimatic mini processor (DP-1VA) (with AC-Adapter BS Type)
06AGQ001F	USB Input Tool Direct (Digimatic USB Cable)
264-020	USB Input Tool
06AGL011	Bidirectional digimatic S1 cable, Flat and straight (1 m)
06AGL021	Bidirectional digimatic S1 cable, Flat and straight (2 m)
12AAJ088	Footswitch
02AZD810D	U-WAVE-R
264-626	U-WAVE-TMB (IP67 type)
264-627	U-WAVE-TMB (Buzzer type)
02AZD730G	U-WAVE-T (IP67 type)
02AZD880G	U-WAVE-T (Buzzer type)
12AA486	U-WAVE T mounting bracket
02AZG011	Bidirectional Diamic S1 cable (160 m)

\*6: A small printer (optionally battery-powered) that can be mounted on the main unit. It includes a printer cable and mounting bracket.

\*7: USB memory devices should be formatted with FAT16/32. NTFS and exFAT are not supported.

### LH-Communication Tool V1.0 software for creating inspection reports and configuring system settings

You can easily create and save inspection reports and configure device parameters.

- Available at Mitutoyo website for free download.
- To connect to a PC, use a USB cable (type A-B).



## Specifications

Model	LH-600F	LH-600FG
Order No.	518-360-13	518-361-13
Power grip	Without power grip	With power grip
Measuring range (Stroke)	0 to 977 mm (600 mm) 0 to 38 in (24 in)	
Digital step	0,0001/ 0,001/ 0,01/ 0,1 mm (selectable) 0,00001/ 0,00001/ 0,0001/ 0,001 in (selectable)	
Accuracy (at 20 °C)	Indication accuracy* <sup>8</sup> $\pm (1,1 + 0,6L / 600) \mu\text{m}$ , L= Measured length (mm)	
	Repeatability* <sup>8</sup> Plane: 0,4 $\mu\text{m}$ (2 $\sigma$ ), Hole: 0,9 $\mu\text{m}$ (2 $\sigma$ )	
	Perpendicularity (forward and backward)* <sup>9</sup> 5 $\mu\text{m}$ (after compensation)	
	Straightness (forward and backward)* <sup>9</sup> 4 $\mu\text{m}$ (mechanical accuracy)	
Driving method(speed)	Motor-driven (5, 10, 15, 20, 25, 30, 40 mm/s: 7 steps) / Manual	
Scale unit	Photoelectric incremental encoder STVC-20Z	
Measuring force	1 N (automatic constant-force function)	
Main unit moving mode	Full-floating (moving) / Semi-floating (measuring) Air bearing (built-in compressor)	
Display unit	8,4 inch touch-screen, LCD	
Adjustment of display unit	Stepless tilt adjustment: 0 to 40° Stepless swivel adjustment: -30 to 180°	
Preventive maintenance	Scale status notification, calibration schedule notification	
Probe diameter compensation	· Semi-automatic compensation using the probe diameter calibration block (standard accessory) · Compensation by inputting the probe diameter	
Power supply	AC adapter 100-240V $\pm$ 10% 50/60Hz/ Battery (NiMH)	
Battery operation time* <sup>10</sup>	Battery powered(standard): 4 hours, Powered by 2 batteries: 8 hours	
Battery charging time* <sup>11</sup>	Approx. 3,5 hours (can be used while charging)	
Dimensions (WxDxH)	238 (W) x 492 (D) x 996 (H) mm	
Mass	26,1 kg	26,6 kg
Operating temperature / humidity ranges	5 to 40 °C/ 20 to 80% RH (non-condensing)	
Data output	Digimatic d2/ S1 (bi-directional communication)	

\*8: Specification determined at in-house ambient temperature

\*10: In-house standard(floating and motor-driven vertical movement, operated at 25%)

\*9: Guaranteed when using the Lever Head (519-521) and Mu-Checker (519-561).

\*11: When ambient temperature is 30 °C or higher, the battery may not be charged sufficiently.

## Dimensions

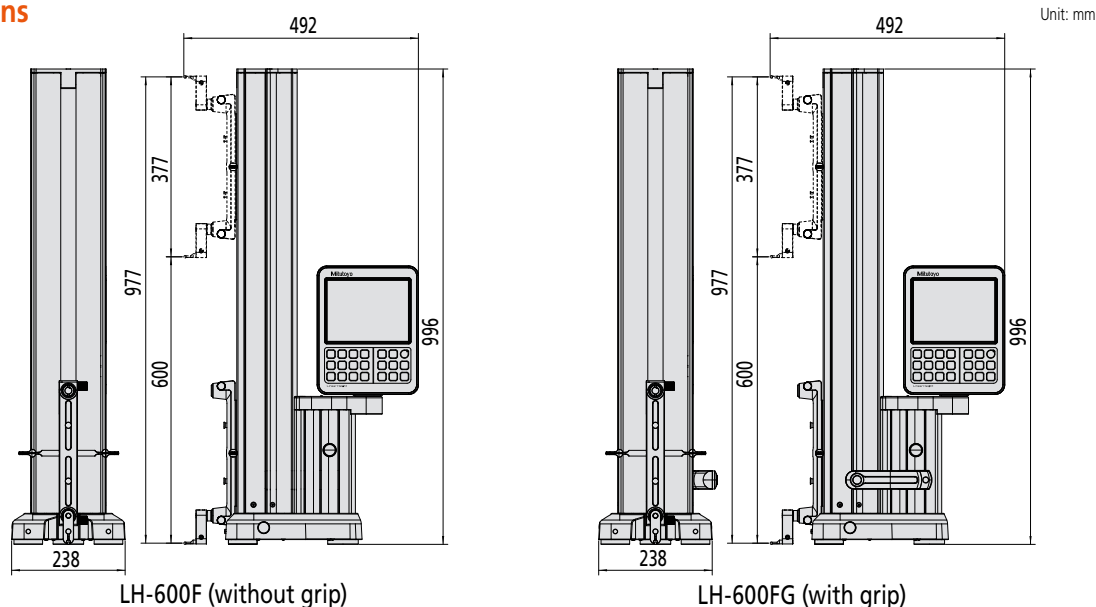

## Standard accessories

ø5 stepped probe, ball-diameter compensation block (with cover and base), auxiliary weight (2 pcs. pre-mounted), battery pack (1 pc)<sup>\*12</sup>, AC adapter, power cable for AC adapter (optional), clear cover, conveying handle, cap, hex wrench, manual set, inspection certificate, Touch pen, protective sheet, Phillips screwdriver

\*12: One piece included as standard. Optional additional battery (using a total of two batteries) for longer battery-powered operation.

## Special accessories

Additional battery pack (Part No.: **12AAF712**), model workpiece (Part No.: **12AAA879**)

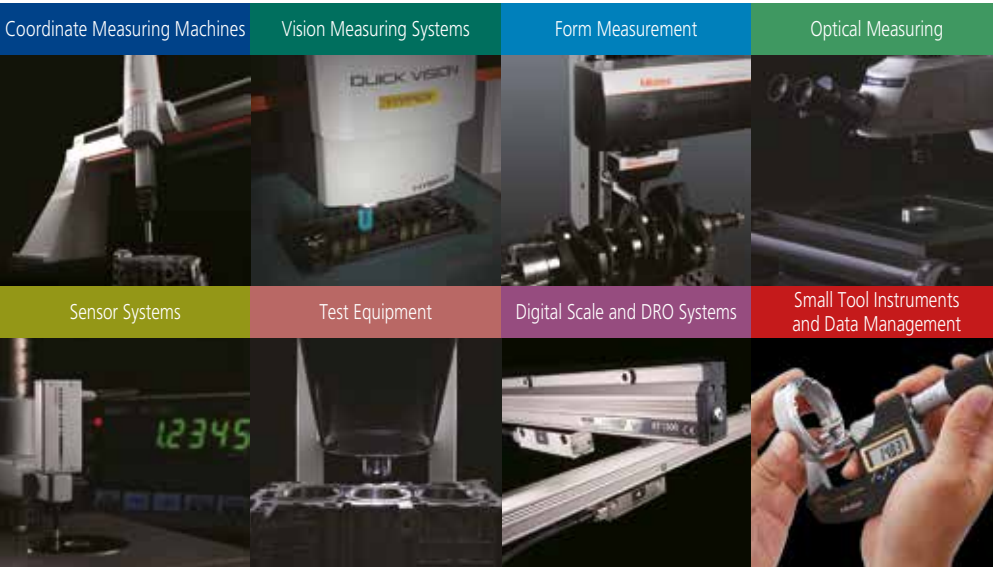

**Whatever your challenges are, Mitutoyo supports you from start to finish.**

Mitutoyo is not only a manufacturer of top quality measuring products but one that also offers qualified support for the lifetime of the equipment, backed up by comprehensive services that ensure your staff can make the very best use of the investment.

Apart from the basics of calibration and repair, Mitutoyo offers product and metrology training, as well as IT support for the sophisticated software used in modern measuring technology. We can also design, build, test and deliver measuring solutions and even, if deemed cost-effective, take your critical measurement challenges in-house on a sub-contract basis.

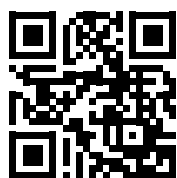

**Find additional product literature and our complete catalog here.**

[www.mitutoyo.eu](http://www.mitutoyo.eu)

**Note:** All information regarding our products, and in particular the illustrations, drawings, dimensional and performance data contained in this printed matter as well as other technical data are to be regarded as approximate average values. We therefore reserve the right to make changes to the corresponding designs, dimensions and weights. The stated standards, similar technical regulations, descriptions and illustrations of the products were valid at the time of printing. In addition, the latest applicable version of our General Trading Conditions will apply. Only quotations submitted by ourselves may be regarded as definitive.

# Mitutoyo

**Mitutoyo Europe GmbH**

Borsigstraße 8-10  
41469 Neuss

Tel. +49 (0) 2137-102-0

[info@mitutoyo.eu](mailto:info@mitutoyo.eu)  
[www.mitutoyo.eu](http://www.mitutoyo.eu)